

SERVICE MANUAL

INTEGRATED DC SERVO
STEREO AMPLIFIER

SANSUI A-1200R/1100R



CAUTION

1. Parts identified by the \triangle symbol on the schematic diagram and the parts list are critical for safety. Use only replacement parts that have critical characteristics recommended by the manufacturer.
2. Make leakage-current or resistance measurements to determine that exposed parts are acceptably insulated from the supply circuit before returning the appliance to the customer.

•SPECIFICATIONS

A-1200R

Power output

Min. RMS, both channels driven, from 20 to 20,000 Hz, with no more than 0.07% total harmonic distortion
125 watts per channel into 8 ohms

Power requirements

Power voltage..... 120/220/240V (50/60 Hz)
For U.S.A. & Canada

..... 120V (60 Hz)

Power consumption.... 360 watts 470 VA Rated

Dimensions 430 mm (16-15/16") W
112 mm (4-7/16") H
250 mm (9-7/8") D

Weight 7.4 kg (16.3 lbs.) net

A-1100R

Power output

Min. RMS, both channels driven, from 20 to 20,000 Hz, with no more than 0.07% total harmonic distortion
100 watts per channel into 8 ohms

Power requirements

Power voltage..... 120/220/240V (50/60 Hz)
For U.S.A. & Canada

..... 120V (60 Hz)

Power consumption.... 350 watts 450 VA Rated

Dimensions 430 mm (16-15/16") W
112 mm (4-7/16") H
250 mm (9-7/8") D

Weight 7.2 kg (15.9 lbs.) net

A-1200R/A-1100R

Load impedance..... 8 to 16 ohms

Total harmonic distortion

..... less than 0.07% at or below
rated min. RMS power output

Frequency response (at 1 watt)

..... 5 to 60,000 Hz
+1 dB, -3 dB

RIAA curve deviation (PHONO, 20 Hz to 20 kHz)

..... +0.5 dB, -0.5 dB

Input sensitivity and impedance

(1 kHz, for rated power output)

PHONO..... 2.5 mV/47 kilohms

(Max. input capability; 120mV at 1 kHz, less than
0.1% total harmonic distortion)

TUNER, CD/AUX, TAPE

PLAY..... 150 mV/30 kilohms

Output level (1 kHz)

TAPE REC..... 130 mV into 47 kilohms

Signal to noise ratio (short-circuit, A-network)

PHONO..... 72 dB

TUNER, CD/AUX, TAPE PLAY

..... 95 dB

* Design and specifications subject to changes without notice for improvements.

* Due to local laws and regulations, this unit sold in some areas are not equipped with variable voltage selectors.

Sansui

SANSUI ELECTRIC CO., LTD.

CAUTION

1. The symbols, UL, CSA, SA, BS, UK, EU, AS, XX <EXPORT> and XX-V <EXPORT(V)> on the parts list and the schematic diagram mean followings respectively.
 - UL Manufactured for U.S.A market.
(Underwriters Laboratories approved model.)
 - CSA Manufactured for Canadian market.
 - SA Manufactured for South African market.
 - BS, UK Manufactured for United Kingdom market.
 - EU Manufactured for European market.
 - AS Manufactured for Australian market.
 - XX <EXPORT> Standard Version with Inner Voltage Selector.
 - XX-V <EXPORT(V)> Standard Version with Outer Voltage Selector.
 - NON MARK Common Parts.

2. Some printed circuit boards are not supplied as the assembled. To separate these in this service manual, the stock numbers are not indicated at the ends of the board names. However, the individual parts on the circuit boards are provided by orders.

3. Since some capacitors and resistors are omitted from parts lists in this service manual, refer to the Common Parts List for capacitors & resistors, which was issued on February 1983.

4. Abbreviations in this service manual are as follows.

•Abbreviations List

C.R. : Carbon Resistor	E.B.L. : Low Leak Bi-Polar Electrolytic Capacitor
S.R. : Solid Resistor	Ta.C. : Tantalum Capacitor
Ce.R. : Cement Resistor	F.C. : Film Capacitor
M.R. : Metal Film Resistor	M.P. : Metalized Paper Capacitor
F.R. : Fusing Resistor	P.C. : Polystyrene Capacitor
N.I.R. : Non-Inflammable Resistor	G.C. : Gimmic Capacitor
A.R. : Array Resistor	A.C. : Array Capacitor
C.C. : Ceramic Capacitor	V.R. : Variable Resistor
C.T. : Ceramic Capacitor, Temperature Compensation	S.V.R. : Semi Variable Resistor
E.C. : Electrolytic Capacitor	SW. : Switch
E.L. : Low Leak Electrolytic Capacitor	Chip R. : Chip Resistor
E.B. : Bi-Polar Electrolytic Capacitor	Chip C. : Chip Capacitor

1. BLOCK DIAGRAM

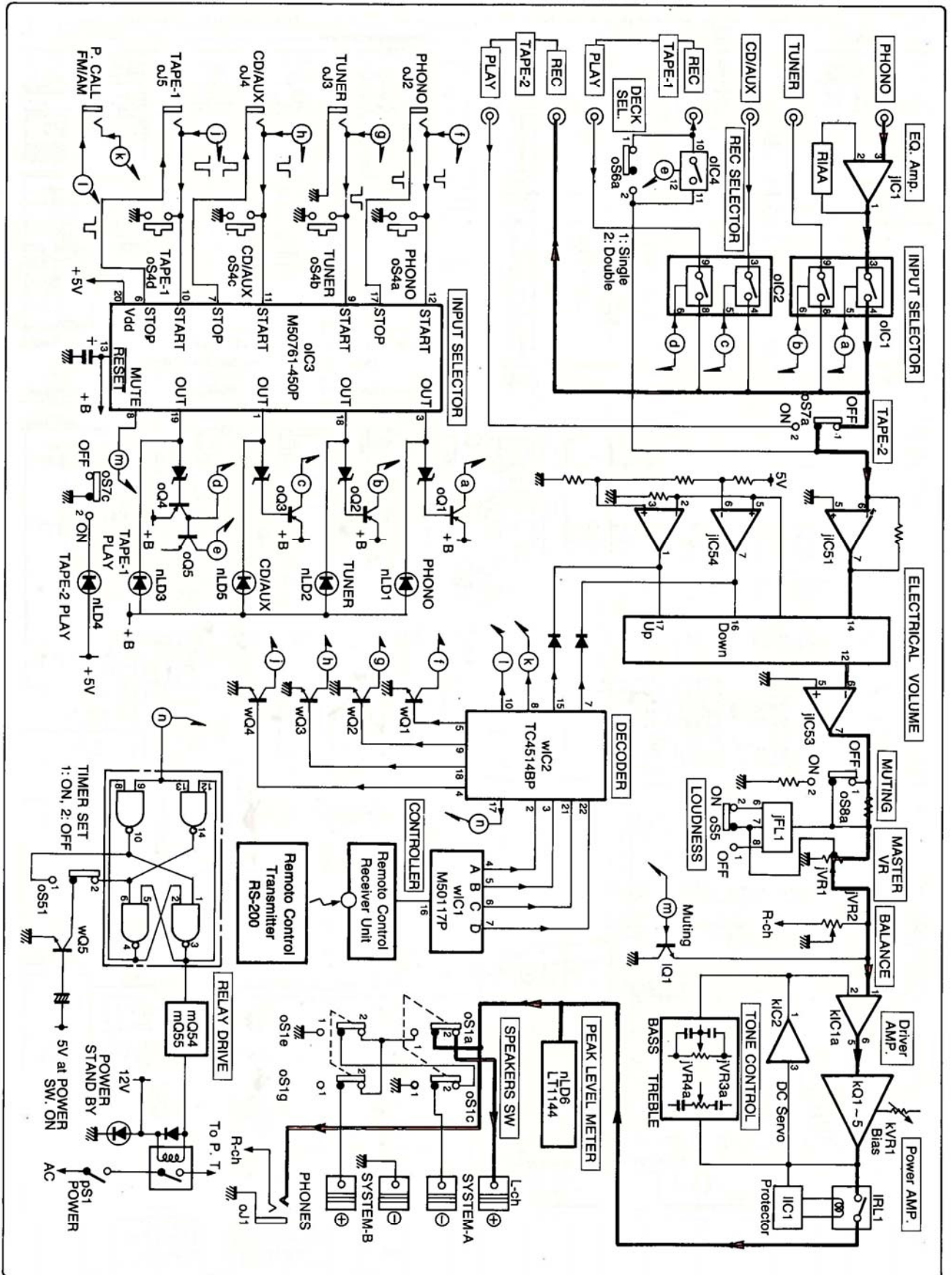

2. PARTS LOCATION & PARTS LIST

2-1. F-4759 Equalizer Amp. Board (Stock No. 00852601)

Component Side

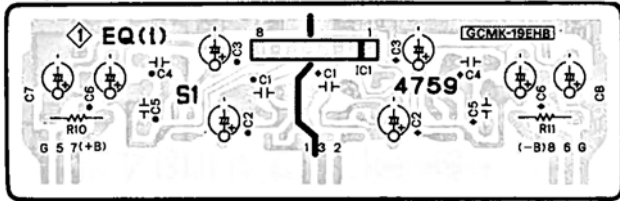

Pattern Side <Chip Parts>

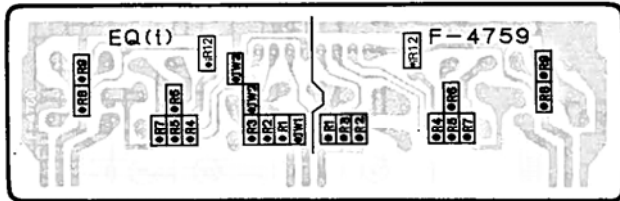

•Note: On this circuit board, the left channel is specified by "●" mark on top of the parts number.

Parts List

Parts No.	Stock No.	Description
•IC		
iC1	46078900	M5218L
iJW1	46741100	Cross Conductor (Chip)
iJW2	46741100	Cross Conductor (Chip)
iJW3	46741100	Cross Conductor (Chip)
iR1	46752400	100kΩ 1/8W Chip R.
iR2	46746800	470Ω 1/8W Chip R.
iR3	46752400	100kΩ 1/8W Chip R.
iR4	46746900	510Ω 1/8W Chip R.
iR5	46746900	510Ω 1/8W Chip R.
iR6	46750800	22kΩ 1/8W Chip R.
iR7	46753500	300kΩ 1/8W Chip R.
iR8	46746800	470Ω 1/8W Chip R.
iR9	46752400	100kΩ 1/8W Chip R.
iR12	46752400	100kΩ 1/8W Chip R.
iC4	46282400	3300pF 50V F.C.
iC5	46283000	0.012μF 50V F.C.

2-2. F-4761 Tone Control Board

Component Side

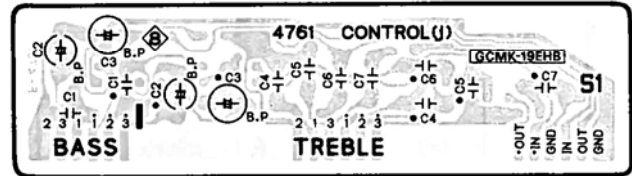

Pattern Side <Chip Parts>

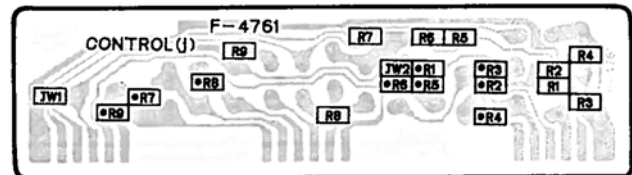

•Note: On this circuit board, the right channel is specified by "●" mark on top of the parts number.

Parts List

Parts No.	Stock No.	Description
iJW1	46741100	Cross Conductor (Chip)
iJW2	46741100	Cross Conductor (Chip)
iR1	46750200	12kΩ 1/8W Chip R.
iR2	46748200	1.8kΩ 1/8W Chip R.
iR3	46753400	270kΩ 1/8W Chip R.
iR4	46751000	27kΩ 1/8W Chip R.
iR5	46751700	51kΩ 1/8W Chip R.
iR6	46748400	2.2kΩ 1/8W Chip R.
iR7	46749400	5.6kΩ 1/8W Chip R.
iR8	46749600	6.8kΩ 1/8W Chip R.
iR9	46747200	680Ω 1/8W Chip R.
iC1	46283600	0.039μF 50V F.C.
iC2	46937000	0.22μF 50V E.B.
iC3	48101800	47μF 10V E.B.
iC4	46281800	1000pF 50V F.C.
iC5	46282800	8200pF 50V F.C.
iC6	46282700	6800pF 50V F.C.

2-3. F-4762 Driver Amp. Board (Stock No. 00987901 = A-1200R/00990701 = A-1100R)

Component Side

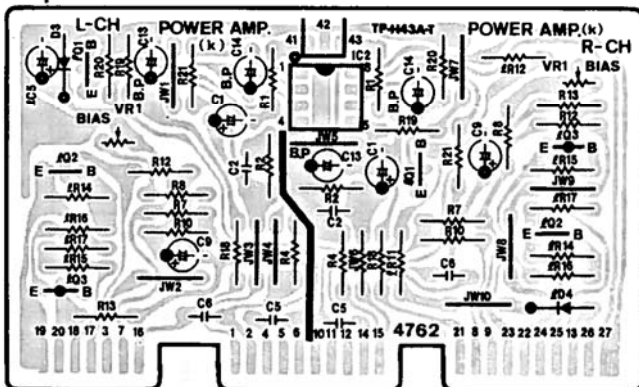

Parts List

Parts No.	Stock No.	Description
•IC		
iC2	03607700	NJM4558D
kC13	48103500	2.2μF 50V E.B.
kC14	48102400	4.7μF 25V E.B.
kVR1	07261600	1kΩ (B) S.V.R., bias adj.
•Transistor		
iQ1	46367301	2SC2458
	or 46581701	2SC1845
iQ2	46367101	2SC2603
	or 46367301	2SC2458
iQ3	46367001	2SA1115
	or 46367201	2SA1048
•Diode		
iD3	03117600	1S2473T77
	or 46086000	1S1588TP-3
iD4	03117600	1S2473T77
	or 46086000	1S1588TP-3

2-4. F-4765 Protector Board (Stock No. 00882401)

Component Side

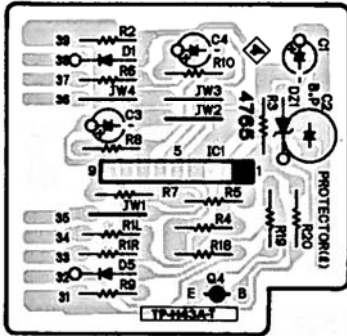

Parts List

Parts No.	Stock No.	Description
• Transistor IQ4	46367001 or 46367201	2SA1115 2SA1048
• IC IIC1	46207600	TA7317P
• Diode ID1	03117600 or 46086000	1S2473T77 1S1588TP-3
ID5	03117600 or 46086000	1S2473T77 1S1588TP-3
• Zener Diode IDZ1	46115400	05Z20-Y
IC2	48101500	100μF 6.3V E.B.

2-5. F-4769 CD/AUX, TAPE-1 & TAPE-2 Input Terminal Board (Stock No. 00988601 = A-1200R/00991301 = A-1100R)

Component Side

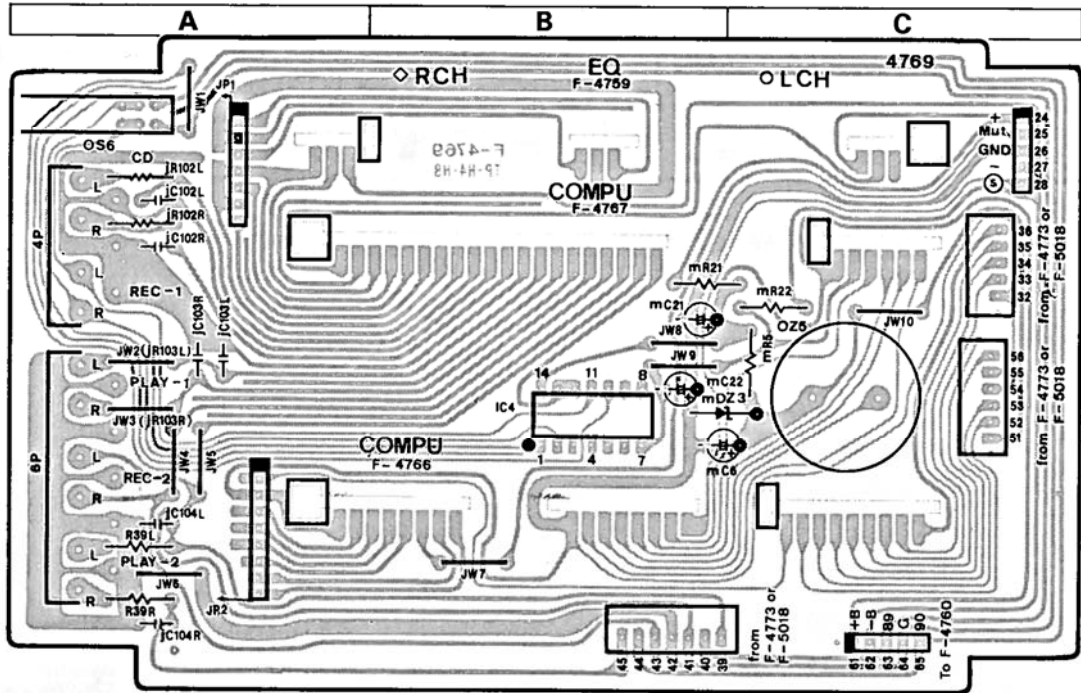

Parts List

Parts No.	Stock No.	Description
• Zener Diode mDZ3	46100900 or 46101000	05Z5.1-X 05Z5.1-Y
• IC oIC4	46255000 or 48056800	LC4066BH LC4966

Parts No.	Stock No.	Description
oS6	46670600	Push SW., DECK SELECTOR
oZ3	48528600	6P Terminal, CD/AUX, TAPE-1
oZ6	48528500	4P Terminal, TAPE-2

2-6. F-4766 Input Selector Control Board

(Stock No. 00988301 = A-1200R/00991001 = A-1100R)

Component Side

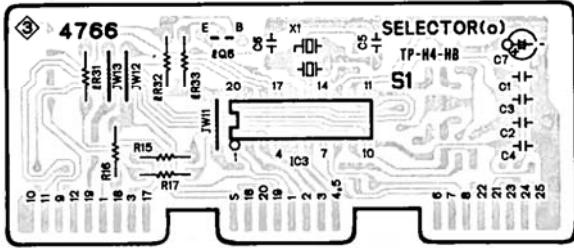

Pattern Side <Chip Parts>

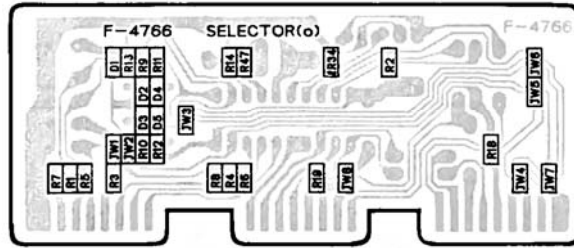

Parts List

Parts No.	Stock No.	Description
•Transistor		
IQ6	46367101 or 46367301	2SC2603 2SC2458
IR34	46749200	4.7kΩ 1/8W Chip R.
•IC		
oIC3	48158300	M50761-450P
oXO1	46396200 or 46668700	Ceramic Element CSB400P Ceramic OSC Element KBR-400B
•Diode		
oD1	46852000	RLS-73 (Chip)
oD2	46852000	RLS-73 (Chip)
oD3	46852000	RLS-73 (Chip)
oD4	46852000	RLS-73 (Chip)
oD5	46852000	RLS-73 (Chip)
oJW1	46741100	Cross Conductor (Chip)
oR1	46747600	1kΩ 1/8W Chip R.
oR2	46749200	4.7kΩ 1/8W Chip R.
oR3	46747600	1kΩ 1/8W Chip R.
oR4	46748000	1.5kΩ 1/8W Chip R.
oR5	46747600	1kΩ 1/8W Chip R.
oR6	46748000	1.5kΩ 1/8W Chip R.
oR7	46747600	1kΩ 1/8W Chip R.
oR8	46748000	1.5kΩ 1/8W Chip R.
oR9	46750000	10kΩ 1/8W Chip R.
oR10	46750000	10kΩ 1/8W Chip R.
oR11	46750000	10kΩ 1/8W Chip R.
oR12	46750000	10kΩ 1/8W Chip R.
oR13	46752400	100kΩ 1/8W Chip R.
oR14	46754800	1MΩ 1/8W Chip R.
oR18	46746600	390Ω 1/8W Chip R.
oR19	46751800	56kΩ 1/8W Chip R.
oR47	46748700	3kΩ 1/8W Chip R.

2-7. F-4767 Input Signal Selector Board

(Stock No. 00988401 = A-1200R/00991101 = A-1100R)

Component Side

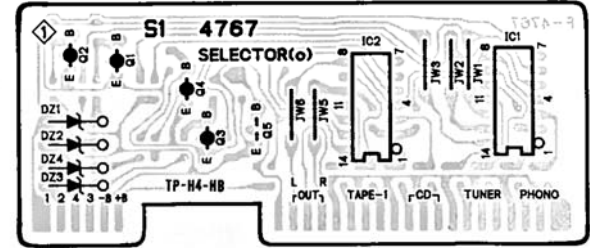

Pattern Side <Chip Parts>

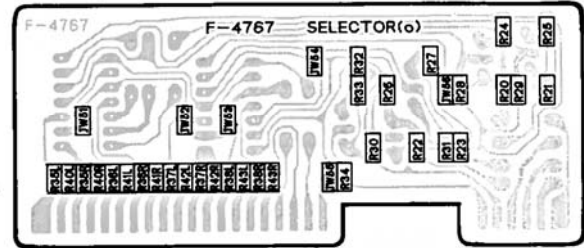

Parts List

Parts No.	Stock No.	Description
•Transistor		
oQ1	46188601 or 46367001 or 46367201	2SA1015 2SA1115 2SA1048
oQ2	46188601 or 46367001 or 46367201	2SA1015 2SA1115 2SA1048
oQ3	46188601 or 46367001 or 46367201	2SA1015 2SA1115 2SA1048
oQ4	46188601 or 46367001 or 46367201	2SA1015 2SA1115 2SA1048
oQ5	46188701 or 46367101 or 46367301	2SC1815 2SC2603 2SC2458
•IC		
oIC1	46255000 or 48056800	LC4066BH LC4966
oIC2	46255000 or 48056800	LC4066BH LC4966
•Zener Diode		
oDZ1	46112700	05Z8.2-Y
oDZ2	46112700	05Z8.2-Y
oDZ3	46112700	05Z8.2-Y
oDZ4	46112700	05Z8.2-Y
oJW51	46741100	Cross Conductor (Chip)
oR20	46747200	680Ω 1/8W Chip R.
oR21	46747200	680Ω 1/8W Chip R.
oR22	46747200	680Ω 1/8W Chip R.
oR23	46747200	680Ω 1/8W Chip R.
oR24	46749200	4.7kΩ 1/8W Chip R.
oR25	46749200	4.7kΩ 1/8W Chip R.
oR26	46749200	4.7kΩ 1/8W Chip R.
oR27	46749200	4.7kΩ 1/8W Chip R.
oR28	46751600	47kΩ 1/8W Chip R.
oR29	46751600	47kΩ 1/8W Chip R.
oR30	46751600	47kΩ 1/8W Chip R.
oR31	46751600	47kΩ 1/8W Chip R.
oR32	46750800	22kΩ 1/8W Chip R.
oR33	46749200	4.7kΩ 1/8W Chip R.
oR34	46751600	47kΩ 1/8W Chip R.
oR35	46749200	4.7kΩ 1/8W Chip R.
oR36	46749200	4.7kΩ 1/8W Chip R.
oR37	46749200	4.7kΩ 1/8W Chip R.
oR38	46749200	4.7kΩ 1/8W Chip R.
oR40	46754000	470kΩ 1/8W Chip R.
oR41	46754000	470kΩ 1/8W Chip R.
oR42	46754000	470kΩ 1/8W Chip R.
oR43	46754000	470kΩ 1/8W Chip R.

2-8. F-5121 Power Amp. & Power Supply Board (Stock No. 00988901 = A-1200R/00991601 = A-1100R)

Component Side

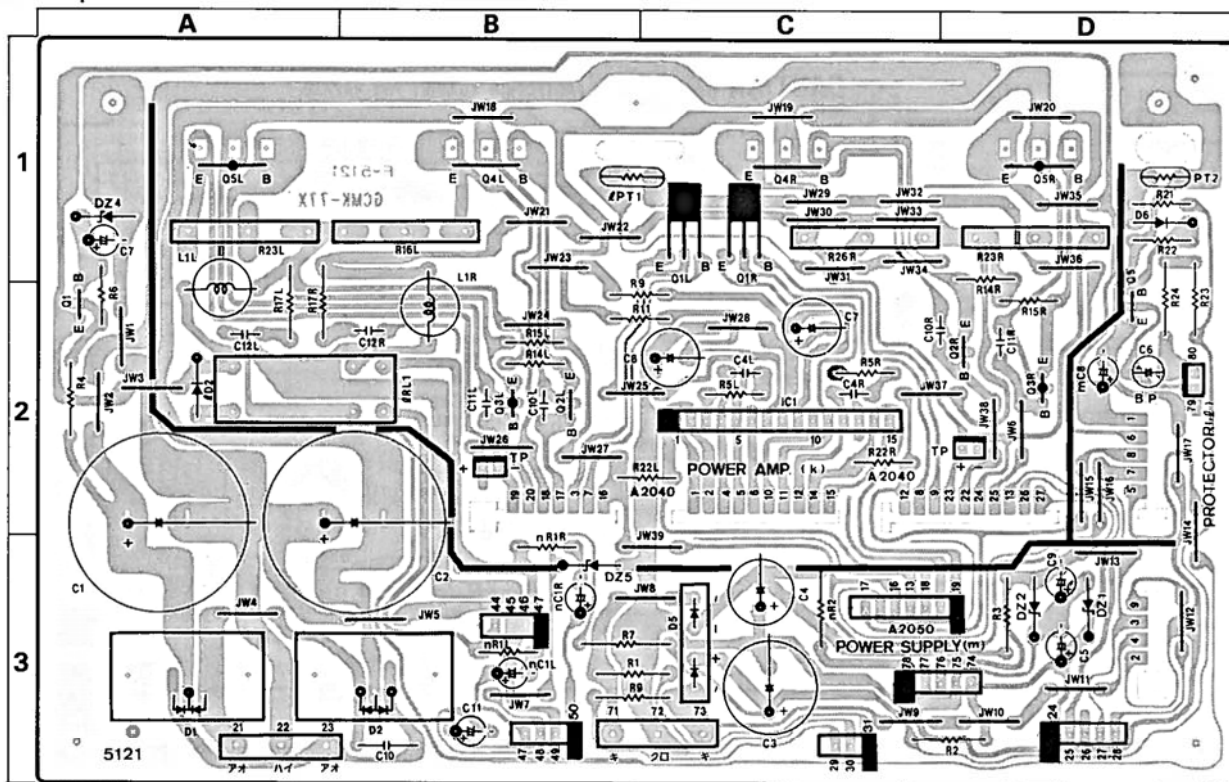

Parts List

Parts No.	Stock No.	Description	Parts No.	Stock No.	Description
• Transistor			Δ IR14	46229000	100Ω 1/2W N.I.R.
Δ kQ1	03067401	2SC1845	Δ IR15	46229000	100Ω 1/2W N.I.R.
Δ kQ2	48170001	2SC2592	Δ IR16	46230400	1.5kΩ 1/2W N.I.R.
Δ kQ3	or 48263101	2SC3298A	Δ IR17	46230400	1.5kΩ 1/2W N.I.R.
Δ kQ4	48169901	2SA1112	Δ IR23	46248900	47Ω 1W N.I.R.
Δ kQ5	or 48263001	2SA1306A	Δ IR24	46249300	100Ω 1W N.I.R.
Δ kR9	46228400	33Ω 1/2W N.I.R.	IC6	48103600	3.3μF 50V E.B.
Δ kR11	46228400	33Ω 1/2W N.I.R.	IRL1	48183100	Relay
Δ kR12	46228600	47Ω 1/2W N.I.R.	or 48183200	Relay	
Δ kR13	46228600	47Ω 1/2W N.I.R.	• Transistor		
Δ kR14	46229200	150Ω 1/2W N.I.R.	Δ mQ1	03083901	2SD313HP
Δ kR15	46229200	150Ω 1/2W N.I.R.	Δ	or 46546701	2SD880
Δ kR16	07235100	0.47ΩX2 5W Ce.R.	Δ	or 48073601	2SD1061
Δ kR17	46248100	10Ω 1W N.I.R.	• Diode		
Δ kR23	07235100	0.47ΩX2 5W Ce.R.	Δ mD1	48159900	CTM-22S
Δ kR51	46249700	220Ω 1W N.I.R.	Δ mD2	48159800	CTM-22R
kC7	46312800	47μF 100V E.C.	Δ mD5	03117000	RB152-LFF
kC8	46312800	47μF 100V E.C.	• Zener Diode		
kC12	46283700	0.047μF 50V F.C.	mDZ1	03150601	EQB01-12
kL1	46851901	Filter Coil 0.82μH	or 03170300	RD12F	
• Transistor			03150601	EQB01-12	
IQ5	48061801	2SC3244	or 03170300	RD12F	
• Diode			mDZ4	46116000	05Z24-Y
ID2	48123600	11E2	or 46116100	05Z24-Z	
ID6	03117600	1S2473T77	mDZ5	03156000	EQB01-10
or 46086000	1S1588TP-3		or 03169900	RD10F	
IPT1	48484100	Thermistor ZPP221E501A120	Δ mR1	46248700	33Ω 1W N.I.R.
IPT2	48262700	Thermistor ZPP220T501A80	Δ mR2	46624500	150Ω 2W N.I.R.
			Δ mR3	46249600	180Ω 1W N.I.R.
			Δ mR4	46250300	680Ω 1W N.I.R.
			Δ mR5	46229500	270Ω 1/2W N.I.R. (XX-V)
			Δ	46229600	330Ω 1/2W N.I.R. (UL & CSA)
			Δ mR7	46624400	120Ω 2W N.I.R.
			Δ mR9	46248700	33Ω 1W N.I.R.
			mC1	48201400	8200μF 80V E.C.
			mC2	48201400	8200μF 80V E.C.
			mC10	08680400	0.01μF 500V C.C.

2-9. F-5458 Power SW. & Power Supply Board (Stock No. 00989001 = A-1200R/00991701 = A-1100R)

Component Side

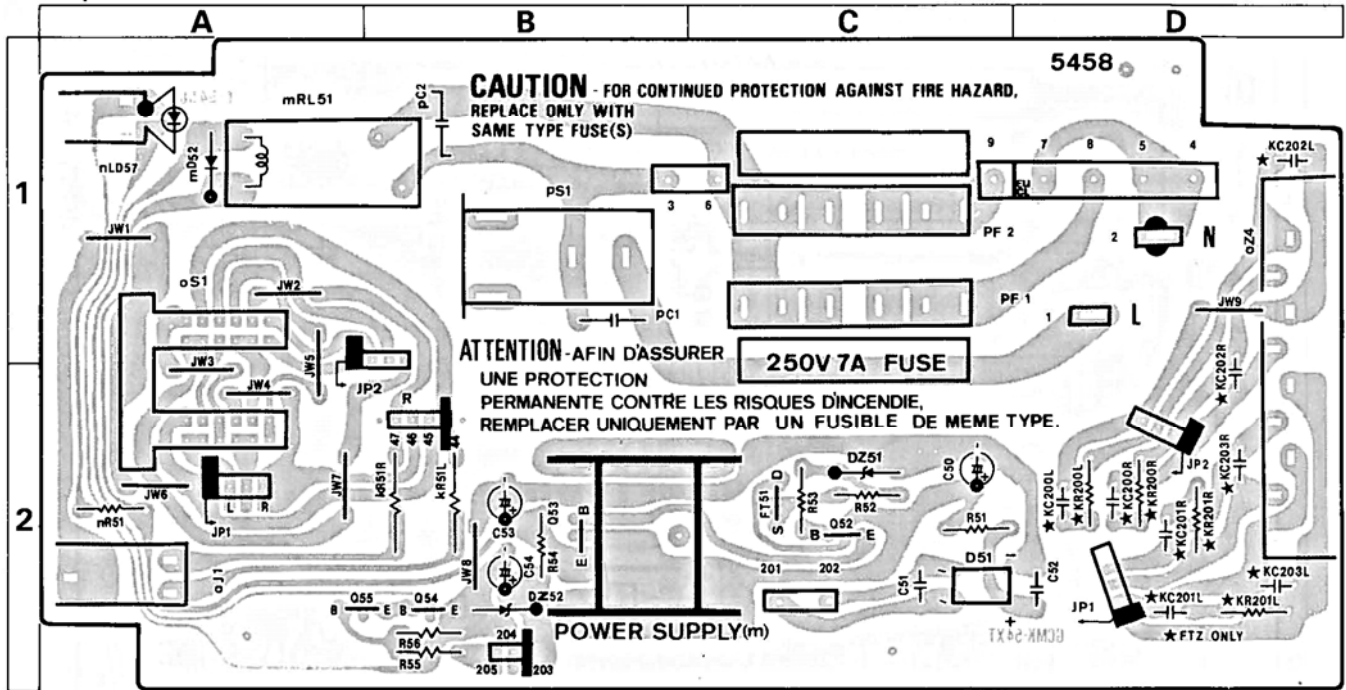

Parts List

Parts No.	Stock No.	Description
kC200	46283700	0.047 μ F 50V F.C.
kC201	46283700	0.047 μ F 50V F.C.
•Transistor		
mQ52	46367101	2SC2603
mQ53	48527001	2SD880
mQ54	46367101	2SC2603
mQ55	46367101	2SC2603
•FET		
mFT51	46643502	2SK163-L1
	or 46643503	2SK163-L2
	or 46643504	2SK163-M1
	or 46643505	2SK163-M2
	or 46643506	2SK163-N1
	or 46643507	2SK163-N2
	or 46643602	2SK117-GR
	or 46643603	2SK117-BL
	or 46643701	2SK246-GR
	or 46643702	2SK246-BL
•Diode		
Δ mD51	46273600	DBB10B
Δ	or 46273700	DBB10C
Δ	or 48192000	DBB10E
Δ	or 48192100	DBB10G
mD52	03117700	10E-2
•Zener Diode		
mDZ51	46114200	05Z13-Y
	or 46114300	05Z13-Z
	or 46114400	05Z15-X
	or 46827800	RD13E-B2

Parts No.	Stock No.	Description
	or 46827900	RD13E-B3
	or 46828000	RD15E-B1
mDZ52	46111200	05Z5.1-Y
	or 46824700	RD5.1E-B2
Δ mR51	46227800	10 Ω 1/2W N.I.R.
Δ mR54	46229600	330 Ω 1/2W N.I.R.
mC50	48589300	220 μ F 50V E.C
Δ mRL51	48340200	Relay
Δ	or 48340300	Relay
•LED		
nLD57	03192400	BR3402S
oS1	48170900	Push SW., SPEAKERS
oJ1	46265700	Headphone Jack
oZ4	46947500	8P Speaker Terminal
Δ pC1	46371700	4700pF 400V C.C.
Δ pC2	46425800	0.01 μ F 400V C.C.
Δ	or 46943200	0.01 μ F 400V C.C.
Δ pF1	48267100	AC Fuse 3.5A 250V (XX-V)
Δ	48267500	AC Fuse 7A 250V (UL & CSA)
Δ pF2	48267100	AC Fuse 3.5A 250V (XX-V)
Δ pS1	48113300	Push SW., POWER (XX-V, UL)
Δ	48065100	Push SW., POWER (CSA)

2-10. F-5459 Master Volume Board

Component Side

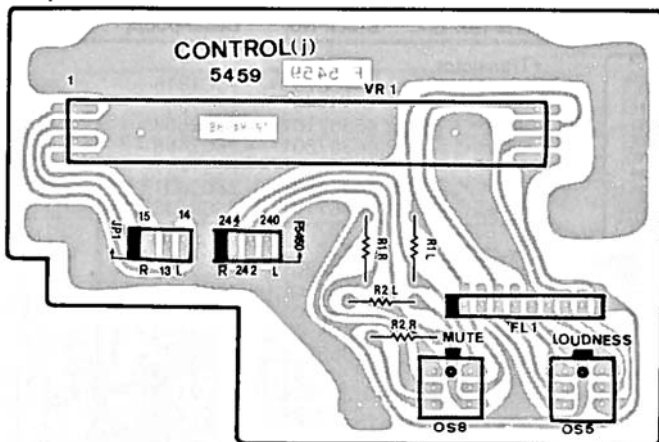

Parts List

Parts No.	Stock No.	Description
jFL1	48172000	CR Module
jVR1	48171000	150kΩ (B) V.R., VOLUME
oS5	48224600	Push SW., LOUDNESS
oS8	48224600	Push SW., MUTING

2-11. F-5460 Electric Volume Control Board (Stock No. 00989301 = A-1200R/00994201 = A-1100R)

Component Side

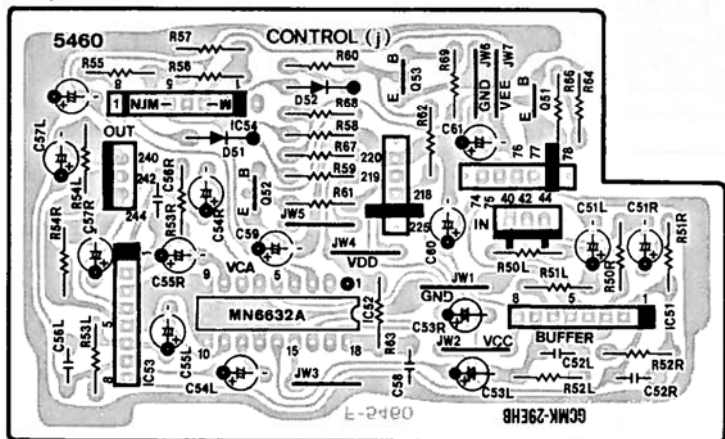

Parts List

Parts No.	Stock No.	Description
• Transistor		
jQ51	46367101	2SC2603
	or 46367301	2SC2458
jQ52	46367101	2SC2603
	or 46367301	2SC2458
jQ53	46367101	2SC2603
	or 46367301	2SC2458
• IC		
jIC51	46078900	M5218L
	or 46579100	M5219L
jIC52	48483500	MN6632A
jIC53	46078900	M5218L
	or 46579100	M5219L
jIC54	46087100	NJM4558S
	or 46147700	M5218L
• Diode		
jD51	03117600	1S2473T77
	or 46086000	1S1588TP-3
jD52	03117600	1S2473T77
	or 46086000	1S1588TP-3
jC53	46928500	10μF 16V E.C.
jC54	46928500	10μF 16V E.C.
jC55	46931200	1μF 50V E.C.
jC57	48102000	10μF 16V E.B.

2-12. F-5461 Remoto Control Receiver Unit Board

Component Side

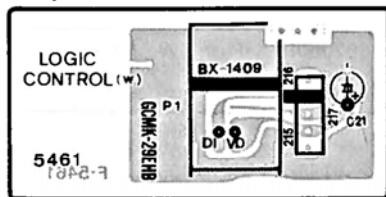

Parts List

Parts No.	Stock No.	Description
wP1	48521000	BX1409 Remoto Control Receiver Unit

2-13. F-5462 Remoto Control Receiver Controller Board (Stock No. 00989501 = A-1200R/00994601 = A-1100R)

Component Side

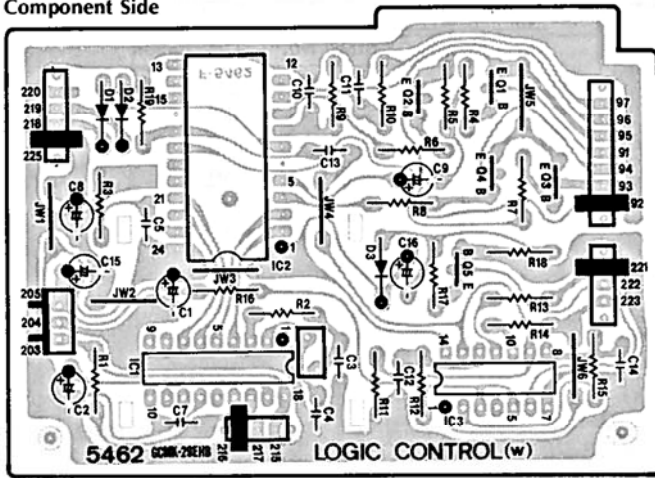

Parts List

Parts No.	Stock No.	Description
• Transistor		
wQ1	46188701	2SC1815
	or 46359801	2SC2001
	or 46367101	2SC2603
wQ2	46188701	2SC1815
	or 46359801	2SC2001
	or 46367101	2SC2603
wQ3	46188701	2SC1815
	or 46359801	2SC2001
	or 46367101	2SC2603
wQ4	46188701	2SC1815
	or 46359801	2SC2001
	or 46367101	2SC2603
wQ5	46188701	2SC1815
	or 46359801	2SC2001
	or 46367101	2SC2603
	or 46367301	2SC2458
• IC		
wIC1	48223600	M50117P
wIC2	48449200	TC4514BP
	or 48509500	μPD4514BC
wIC3	03604100	TC4011P
	or 07200700	MC14011BCP
	or 46631900	M4011BP
wX1	48224300	Ceramic OSC Element KBR-455
• Diode		
wD1	03117600	1S2473T77
	or 46086000	1S1588TP-3
wD2	03117600	1S2473T77
	or 46086000	1S1588TP-3
wD3	03117600	1S2473T77
	or 46086000	1S1588TP-3

2-14. F-5463 Compu Selector Jack Board

Component Side

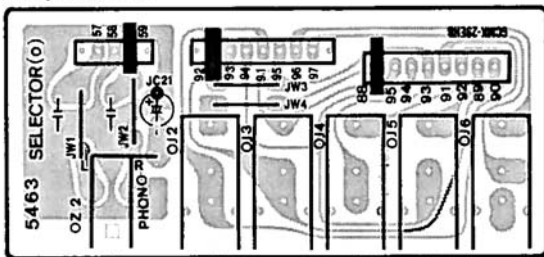

Parts List

Parts No.	Stock No.	Description
oJ2	46547200	Jack, Compu Selector-PHONO
oJ3	46547200	Jack, Compu Selector-TUNER
oJ4	46547200	Jack, Compu Selector-CD/AUX
oJ5	46547200	Jack, Compu Selector-TAPE-1
oJ6	46547200	Jack, TUNER REMOTO
oZ2	48528400	2P Terminal, PHONO

2-15. F-5464 Tuner Remoto Jack Board

Component Side

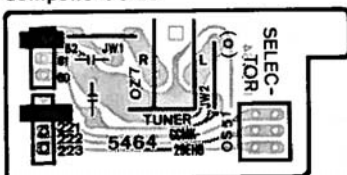

Parts List

Parts No.	Stock No.	Description
oS1	46670600	Push SW., EXT-TIMER SET
oZ7	48528400	2P Terminal, TUNER

2-16. F-5471 BASS, TREBLE & BALANCE Volume Board
Component Side

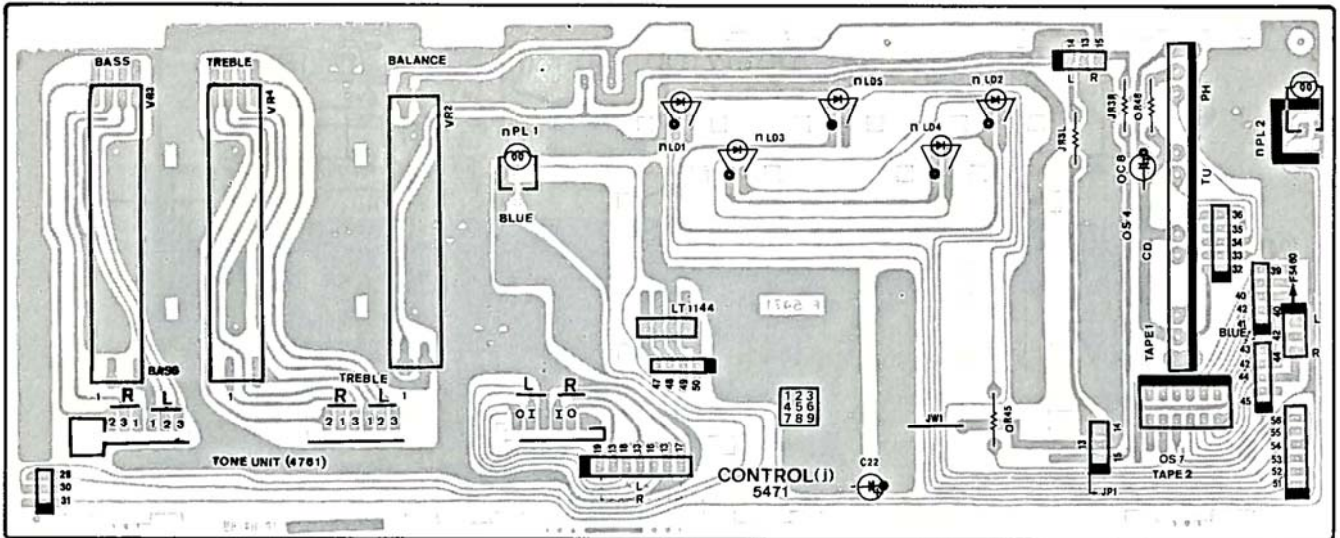

Parts List

Parts No.	Stock No.	Description
jVR2	48171100	250kΩ (W) V.R., BALANCE
jVR3	48171200	50kΩ (C) V.R., BASS
jVR4	48171200	50kΩ (C) V.R., TREBLE
•LED		
nLD1	48172100	BR3447S, PHONO
nLD2	48172100	BR3447S, TUNER
nLD3	48172100	BR3447S, TAPE-1

Parts No.	Stock No.	Description
nLD4	48172100	BR3447S, TAPE-2
nLD5	48172100	BR3447S, CD/AUX
nLD6	48185810	LT1144 Level Meter LED
nPL1	48191900	12V 0.15A Pilot Lamp
nPL2	46286600	12V 0.15A Pilot Lamp
oS4	48178600	Push SW., INPUT SELECTOR
oS7	46556300	Push SW., TAPE-2

3. OTHER PARTS

3-1. Front View

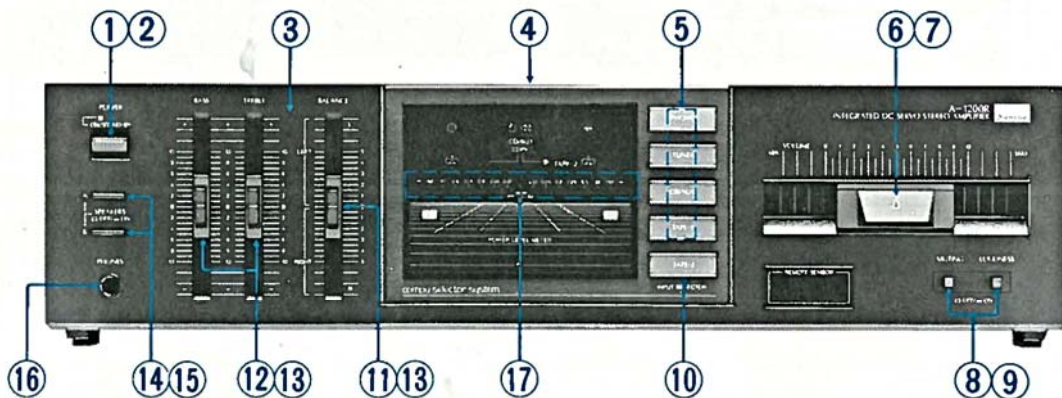

Parts List

Parts No.	Stock No.	Description
1	47746900	Knob, POWER
2	48113300	Push SW., POWER
3	27207700	Front Panel Ass'y (A-1200R)
4	27207500	Front Panel Ass'y (A-1100R)
5	47910200	Bonnet
6	48178600	Push SW., PHONO-TUNER-CD/AUX-TAPE-1
7	48171000	150kΩ (B) V.R., VOLUME
8	47761510	Volume Knob Ass'y
9	48224600	Push SW., MUTING-LOUDNESS

Parts No.	Stock No.	Description
9	47763510	Push Knob, MUTING-LOUDNESS
10	46556300	Push SW., TAPE-2
11	48171100	250kΩ (W) V.R., BALANCE
12	48171200	50kΩ (C) V.R., BASS-TREBLE
13	47732900	Slide Knob, BALANCE-BASS-TREBLE
14	48170900	Push SW., SPEAKERS
15	07911000	Push Knob, SPEAKERS
16	46265700	Head phone Jack
17	48185810	Peak Level Meter LED, LT1144

3-2. Top View

1) A-1200R

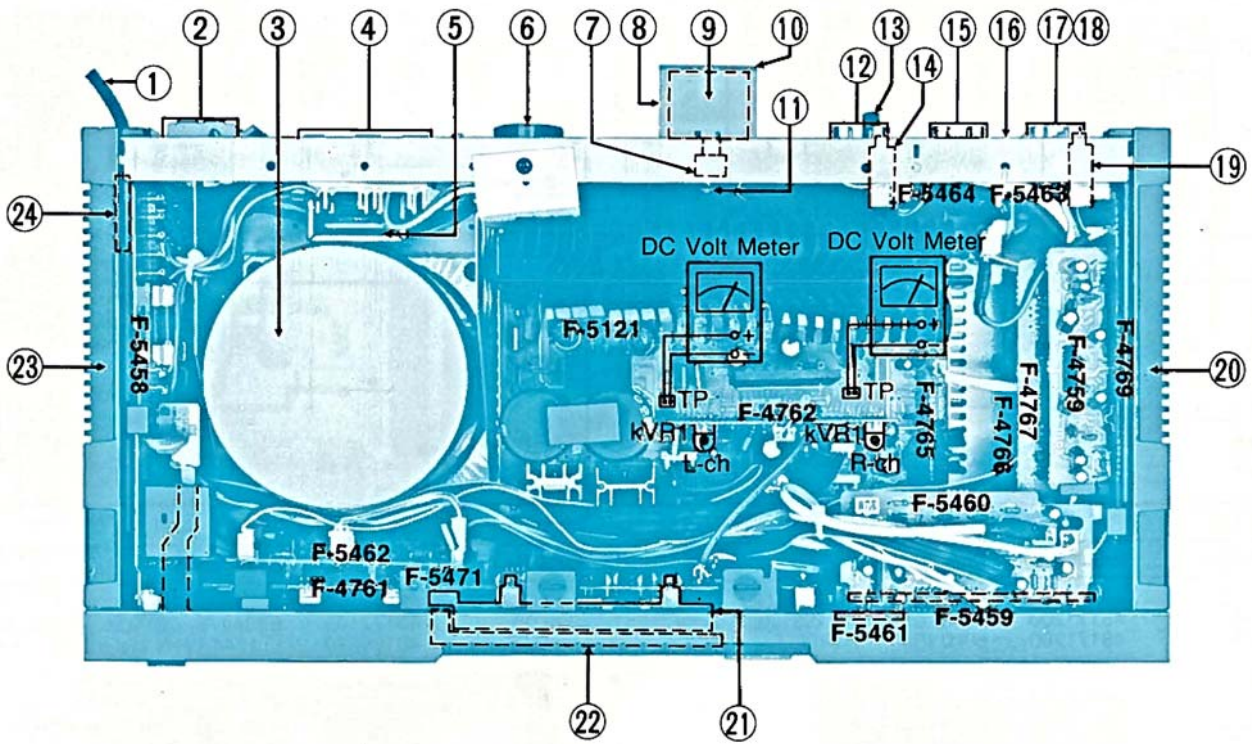

2) A-1100R

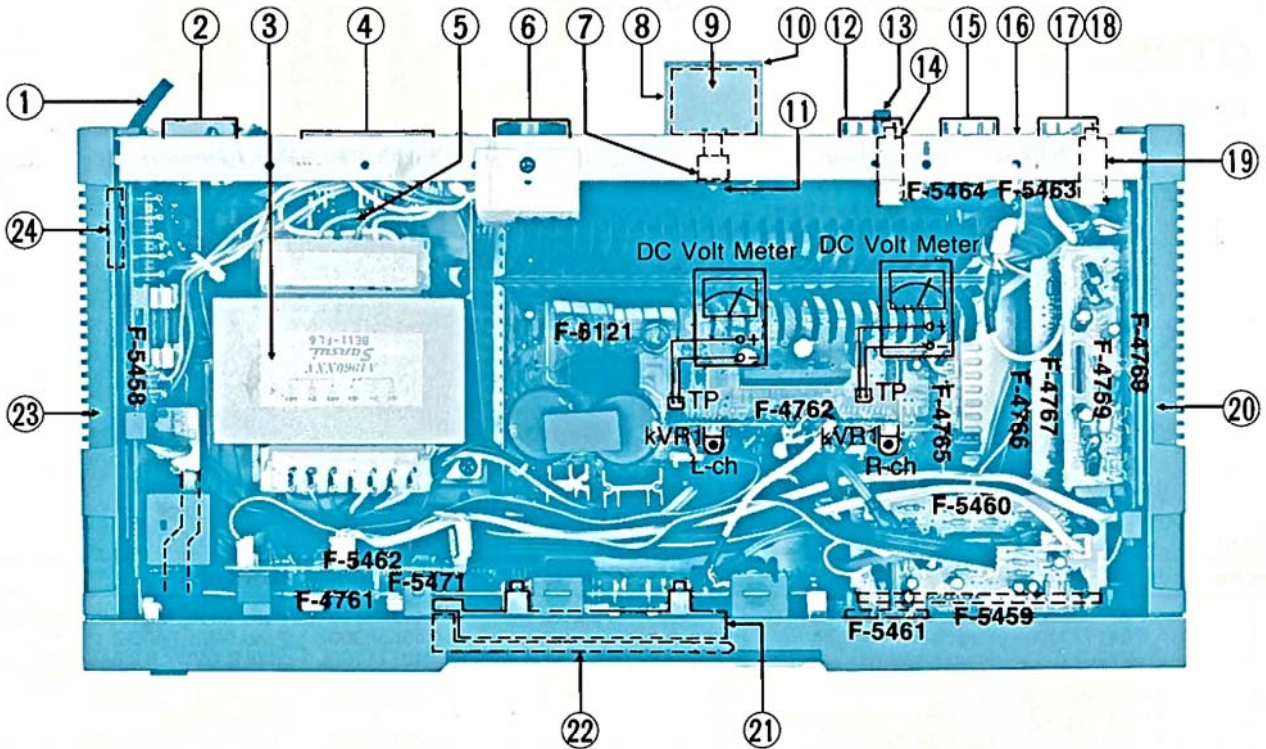

6. SCHEMATIC DIAGRAM 6-1. Main Circuit

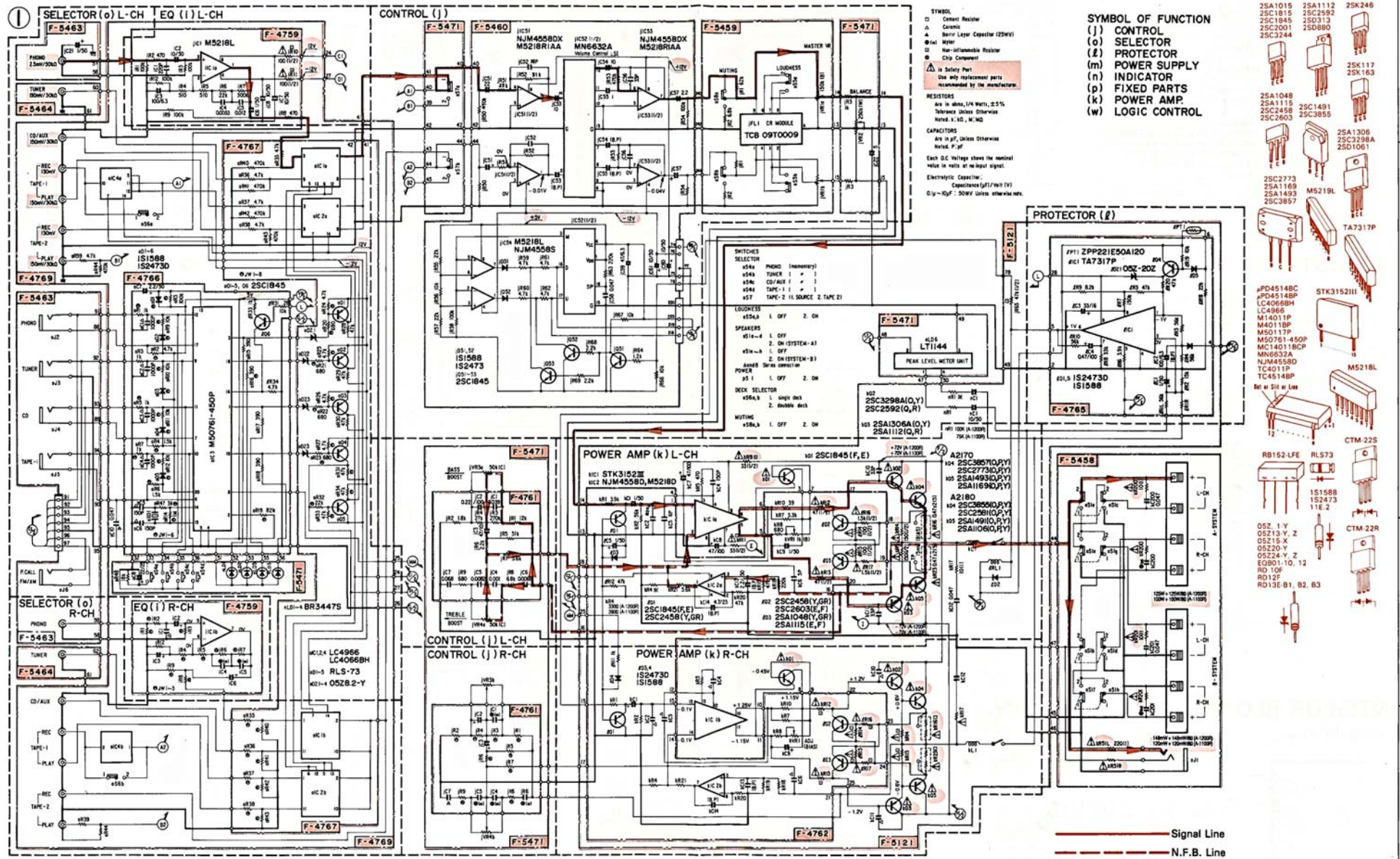

- 2SA1015
- 2SA1112
- 25C1815
- 25C2492
- 25C1845
- 25D313
- 25C2001
- 25D880
- 25C244
- 25C117
- 25K163
- 2SA1048
- 25C1491
- 2SA1115
- 25C2458
- 25C3985
- 25C3603
- 25A1308
- 25C3398A
- 25D1061
- 25C2773
- 25A1168
- 25A1493
- 25C3857
- M5219L
- TA7317P
- PD4514BC
- PD4514BP
- LC4068BH
- LC4966
- M14011P
- MA0118P
- MS0117P
- MS0761-450P
- MC140118CP
- MM6632A
- NJM4558D
- TC4011P
- TC4514BP
- Set at Site in Line
- MS218L
- RB152-LFE
- RLS73
- 1S1588
- 1S2473
- 11E-2
- OSZ-1-Y
- OSZ13-Y-Z
- OSZ15-X
- OSZ20-Y
- OSZ24-Y-Z
- EQ800-110-12
- RD-10F
- RD12P
- RD13E-B1, B2, B3

7. WIRING DIAGRAM

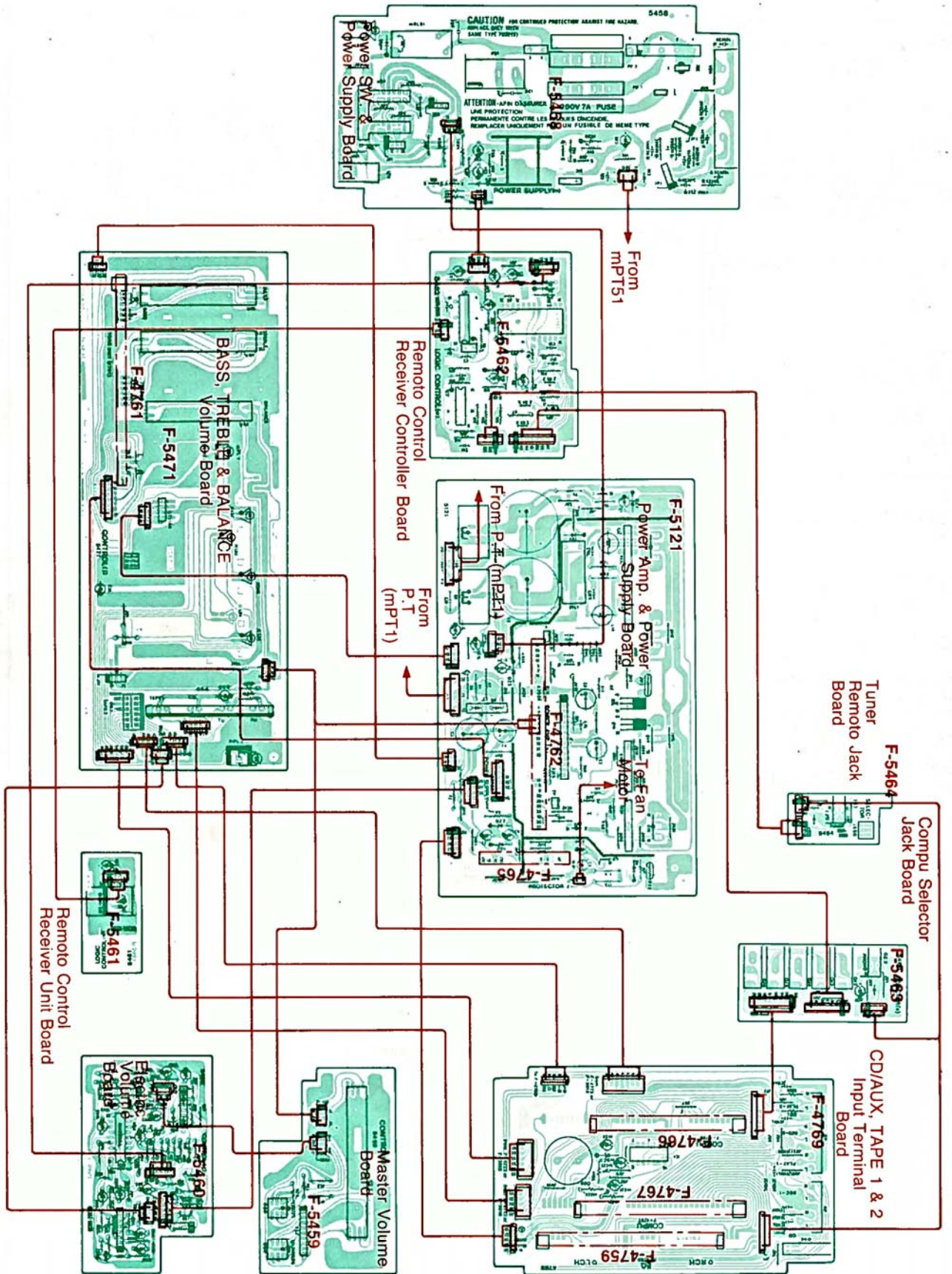

8. PACKING LIST

Parts List

Parts No.	Stock No.	Description
1	27306000	Vinyl Bag
2	27139910	Styrofoam Packing
3	27251400	Sub Packing
4	27207300	Carton Case <A-1200R>
	27207400	Carton Case <A-1100R>

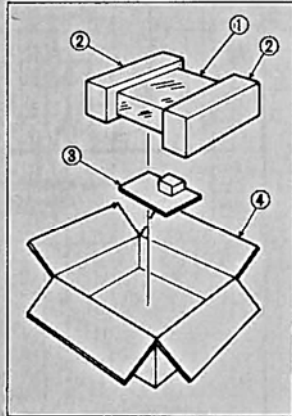
**9. ACCESSORY LIST**

Stock No.	Description
49012100	Operating Instruction <A-1200R/1100R> (XX-V, UL & CSA)
48181700	Mini Pin Plug Cord
	Remoto Controller Unit (RS-200)

SANSUI ELECTRIC CO., LTD.:

SANSUI ELECTRONICS CORPORATION:

SANSUI ELECTRONICS (U.K.) LTD.:
SANSUI ELECTRONICS G.M.B.H.:14-1, Izumi 2-chome, Suginami-ku, Tokyo 168 Japan
PHONE: (03) 324-8891/TELEX: 232-2076 (International Division)
1250 Valley Brook Ave. Lyndhurst, N.J. 07071 U.S.A.
17150 South Margay Ave. Carson, California 90746 U.S.A.
3036 Koapaka Street, Honolulu, Hawaii 96819 U.S.A.Unit 10A, Lyon Industrial Estate, Rockware Avenue, Greenford, Middx UB6, OAA, England
Pau Ehrich Strasse 8, 6074 Rödermark 2, West Germany

(SM1-315)

Printed in Japan (1986.7.M) <Stock No. 36524200>